

Installation

The loudspeaker can be installed both on the ceiling and on a vertical surface. It is strongly recommended that the mounting surface is flat (not curved).



Ensure that the mounting surface is free from obstructions, pipes or studs, either in front and behind the surface.



The cable runs and cable pipes shall be set according to the loudspeaker system configuration. The cables must be of adequate quality, suitable for the installation's environmental conditions and with proper copper section to minimize power loss.

- 1 Remove the grill from the loudspeaker and keep it in a safe place.

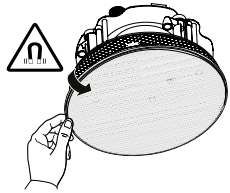

- 2 Position the cutout template and mark the surface accordingly.

- 3 Drill a pilot hole, then cut all of the way around the circular outline with a cutting saw.

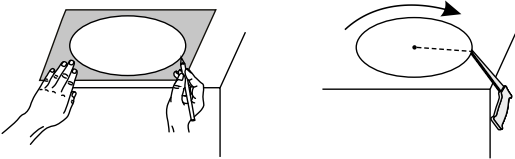

- 4 Pull the speaker wire out of the hole and connect it to the loudspeaker.

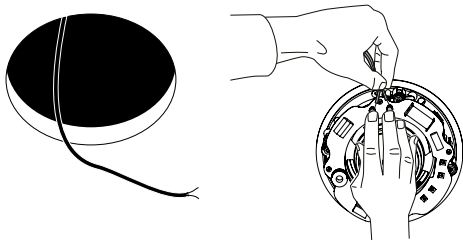

Common input wire (-) is BLACK.
Signal wire (+): connect only one wire among the input taps wires.



Select the input tap wire according to:

- the voltage level of the line;
- the wattage required to produce the desired sound pressure level for your application, allowing for some additional headroom.



The sum of the power taps of the loudspeakers connected to the same line shall be 20% lower than the amplifier's wattage rating.

- 5 Insert the loudspeaker into the hole and tighten all the clamp screws with a Phillips #1 screwdriver.

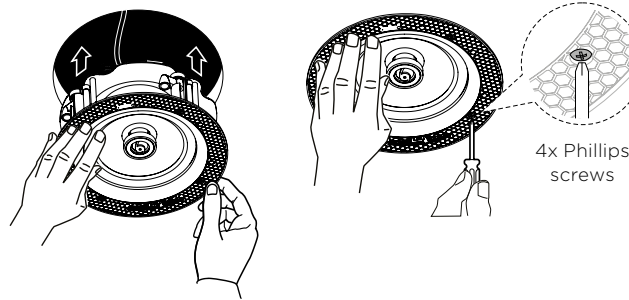

- 6 Reposition the grill on the loudspeaker.

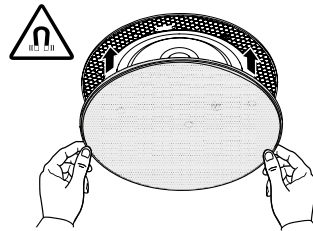

KGEAR
Smart Audio Solutions

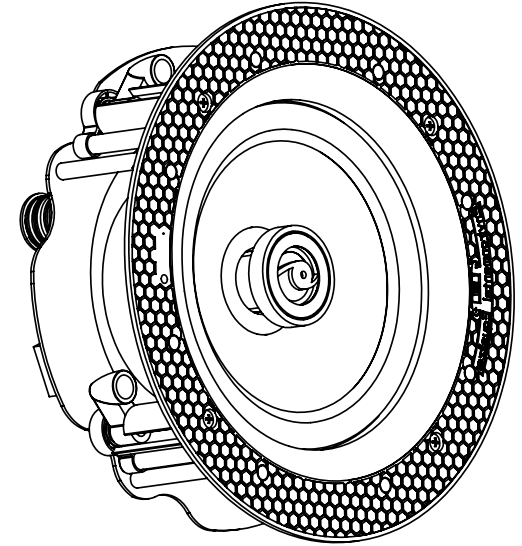

GCF6 / GWF6
GCF6T / GWF6T

6.5" ceiling/in-wall
2-way full range loudspeaker

Thank you for choosing this KGEAR product!

To ensure proper operation, please carefully read this owner's manual and safety instruction before using the product.

After reading this manual, be sure to keep it for future reference.

Loudspeaker Wiring

Ensure that the amplifier is unplugged from the mains before making any connections.

Connect the input terminals of the loudspeakers to the speaker output terminals of the amplifier. Always check to ensure polarity is correct: L(left) to L, R(right) to R, "+" to "+", and "-" to "-".

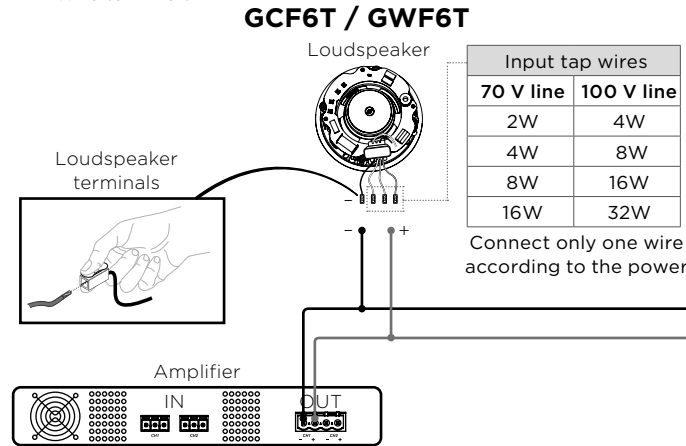
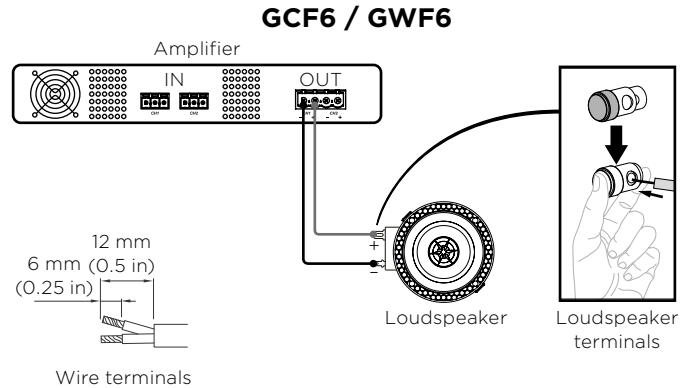

Note: In case of sonic artifacts, roughness or distortion, reduce the signal volume to a lower setting. Never allow the amplifier to be driven into "clipping". Damage caused by operating the speakers at distorted volume levels is not covered by the warranty.

IMPORTANT SAFETY INSTRUCTIONS



Warning. Failure to follow these safety instructions could result in fire, shock or other injury or damage to the device or other property.

- Read these instructions.
- Keep these instructions.
- Heed all warnings.
- Follow all instructions.
- Installation and commissioning may only be carried out by qualified and authorized personnel.
- Do not use this apparatus near water.
- Do not install near any heat sources such as radiators, heat registers, stoves, or other apparatus (including amplifiers) that produce heat.
- Only use attachments/accessories specified by the manufacturer.
- Do not expose this apparatus to dripping or splashing and ensure that no objects filled with liquids, such as vases, are placed on this apparatus.
- Prior to installing the speakers into any ceiling/wall, check the structure for weight bearing ability and avoid contact with any wiring or plumbing that might be behind the surface area.
- Installing on soft materials or in areas incapable of supporting the speakers' weight may cause personal injury or damage to the speaker.
- Make sure the speaker is properly secured to the ceiling/wall. Please use the proper screws, bolts, or anchors. Failure to do so may cause the speaker to become unsecured and cause potential damages/injuries.
- Damage to the woofer and tweeter may occur if the speaker is dropped or hit, resulting in no sound or distorted sound.
- Never overdrive your speakers to the point of distortion and always reduce volume prior to switching input sources.
- Use only approved and certified wiring in your installation, do not stretch or place the wire in contact with sharp objects.
- Prior to removing cables ensure all power to your amplifier and other components is turned off.



This device is in compliance with applicable CE standards and regulations. Before putting the device into operation, please observe the respective country-specific regulations!

Packing List

Upon arrival, carefully inspect the shipping carton, then examine and test your new amplifier. If you find any damage, immediately notify the shipping company. Check that the following parts are supplied with the product.

- 6.5" loudspeaker
- Circular or square grill according to the speaker model
- Cutout template
- This user guide



**6,5" Ceiling/In-Wall
Two-Way Loudspeaker
70.7V / 100V Audio Transformer
Lo-Z 8Ω**

| Technical specifications | |
|------------------------------------|--|
| Type | Passive full range loudspeaker |
| Transducers | 6.5" coaxial Woven Glass Fiber woofer with 0.75" Titanium dome tweeter |
| Frequency Response | 60 Hz - 20 kHz (-10 dB) |
| Sensitivity | 90 dB (1 W, 1 m) |
| Max SPL ¹ | 110 dB (peak) |
| Coverage | 130° |
| GCF6 / GWF6 | |
| Power Handling | 60 W |
| Nominal Impedance | 8 Ω |
| GCF6T / GWF6T | |
| Nominal Line Voltage | 70 V line |
| Power Handling TAP | 2W |
| Power Handling TAP | 4W |
| Power Handling TAP | 8W |
| Power Handling TAP | 16W |
| Nominal Line Voltage | 100 V line |
| Power Handling TAP | 4W |
| Power Handling TAP | 8W |
| Power Handling TAP | 16W |
| Power Handling TAP | 32W |
| Handling & Finishes | |
| Dimensions (∅ outer [∅ inner] x H) | ∅ 227 [210] x 87 mm (∅8.9 [8.3] x 3.4 in) |
| Minimum required mounting depth | 94 mm (3.7 in) |
| Cutout diameter | ∅ 210 mm (∅8.3 in) |
| Weight | 1,52 kg (3.3 lb) |
| IP rating | IP54 |

| | | |
|-------|-------|-------|
| BLACK | GCF6 | GWF6 |
| WHITE | GCF6W | GWF6W |

| | | |
|-------|--------|--------|
| BLACK | GCF6T | GWF6T |
| WHITE | GCF6TW | GWF6TW |



¹ Maximum SPL is calculated using a signal with crest factor 4 (12dB) measured at 1 m.